

Assembly Instructions

RLS-2MR (60T / 70T)

Parts and Tools list

NO.	Name	Qty	NO.	Name	Qty
1	Lifting System	1set	11	M6*12 Screw	8
2	Foot Pad	4	12	Rubber Cushion	6
3	Foot Margin	2	13	ST3.5*19 Screw	2
4	M8*16 Screw	8	14	ST4.8*19 Screw	8
5	Bracket	2			
6	M6*14 Screw	8			
7	M6*10 Screw	8			
8	Support Beam	1			
9	4mm Hex Spanner	1			
10	5mm Hex Spanner	1			

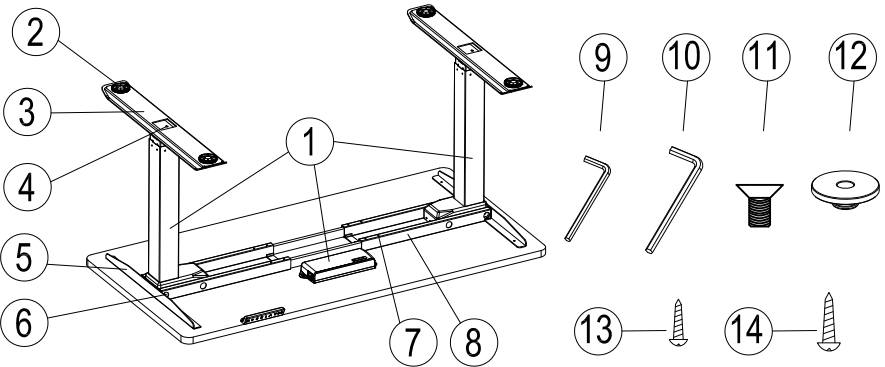

1 Loosen the 4 screws of beam using 4MM hex spanner, adjust the beam to proper position to fit the desktop

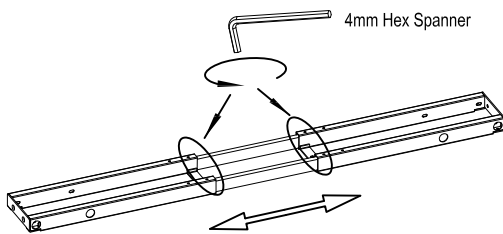

2 Attach legs to the beam using 8 of M6*14 screws and 4 of M6*12 screws

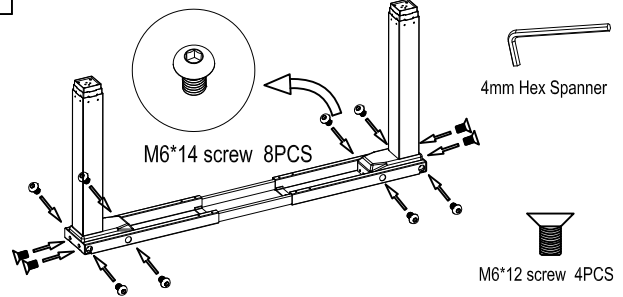

3 Attach feet to the legs using 8 of M8*16 screws, attach the 4 of leveling foot pads to the feet by hand

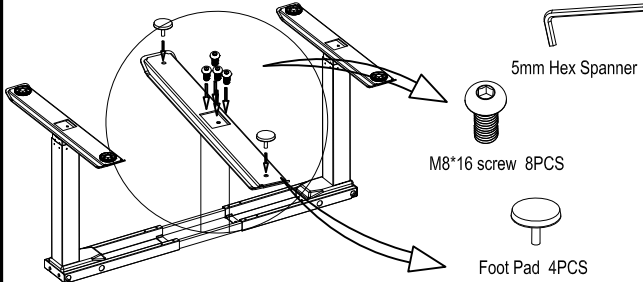

4 Overturn frame and attach brackets to beam using 4 of M6*12 screws, and then fit the rubber cushions to the brackets and beams

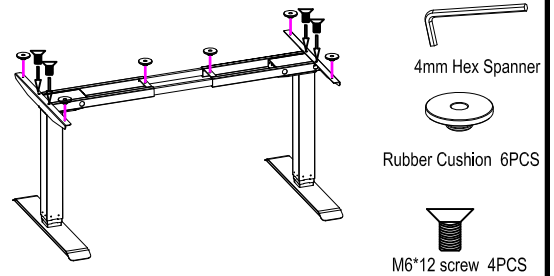

5 Adjust the width of desk frame to fit the desktop by sliding the beam, we recommend leaving at least 5-8CM of the desktop width (on each end) protruding beyond the frame width and centering the side brackets fore and aft

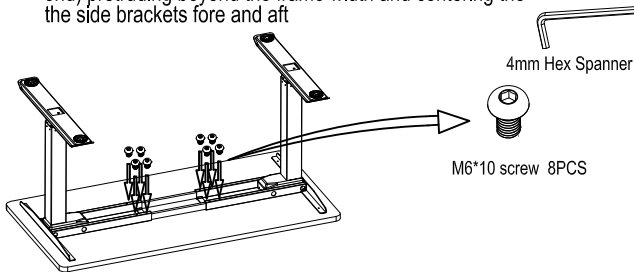

6 Attach the control box to the underside of the desktop using 8 of ST4.8 self-tapping screws, attach handset to the underside of desktop using 2 of ST3.5 self-tapping screw

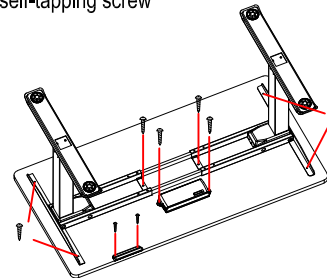

7 Connect the control box to the handset and to the motor

